

Kent Hinged Single Small Fire Rated Access Cover

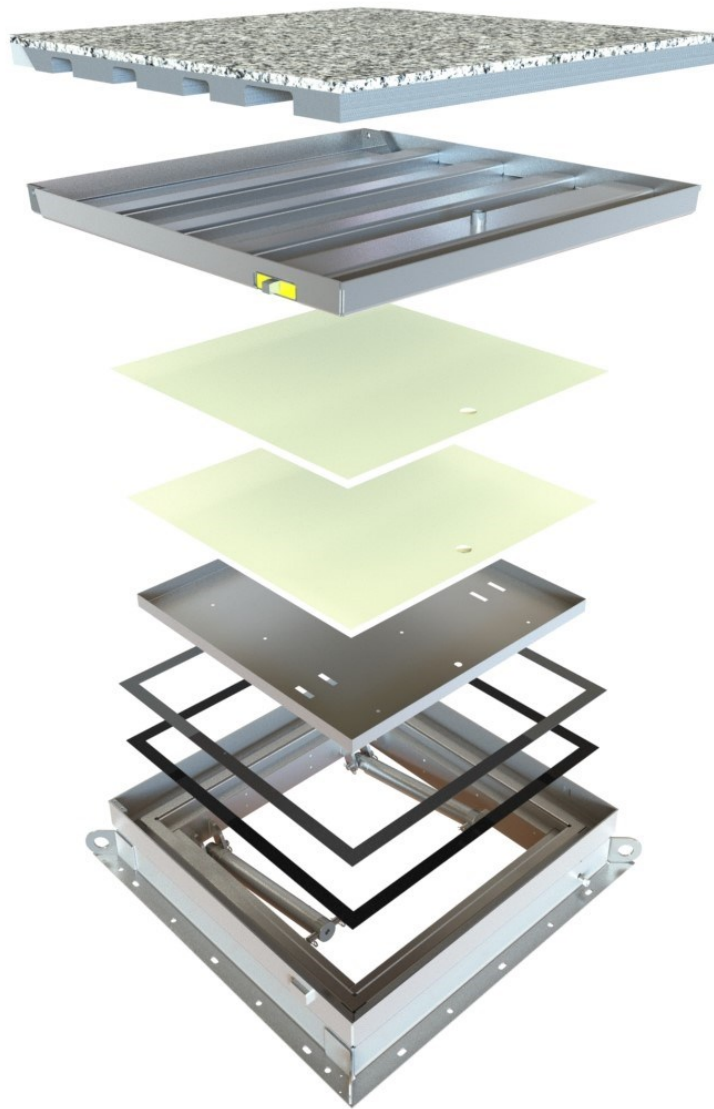

Kent
STAINLESS



KFRAC1000-1000(HLA) is one of our range of Fire Rated Access Covers, designed, manufactured and tested to BSEN 1634-1:2014. 3rd Party Tests are carried out Exova Warrington Fire, notified body No. 0833.

Covers are certified to be used with a concrete/tile infill mainly intended for internal use.

Uniquely they can also be used externally with paver blocks for streetscape, pedestrianised precincts.

Their design also makes them watertight by default

A 1000mm x 1000mm clear opening gives a 1375mm x 1375mm visible frame size. When a cover is opened to 75° the opening is reduced by 200mm on the hinged side.

This cover is for frequent access to the chamber below.

As standard it is operated by mechanical struts made from grade 316L steel with a 10 year warranty.

The hinges are formed from a single block of 20mm thick stainless steel

Features:

- Grade 316L Stainless Steel
- 180 Minute Fire Rating
- Integrity Rated and Insulation Rated
- Water Tight
- Loading 5kN/m²

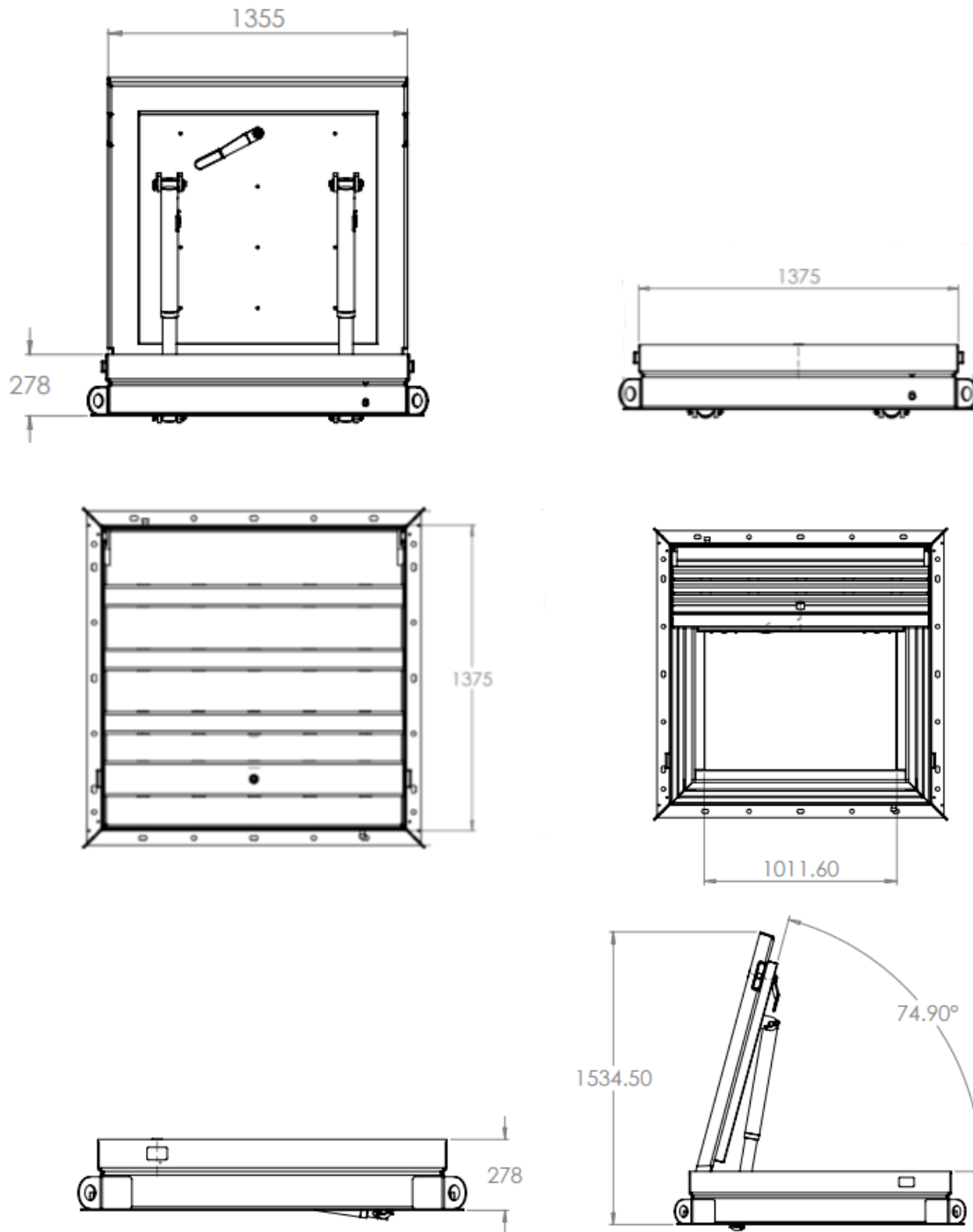

KENT HINGED SINGLE FIRE RATED ACCESS COVER KFRAC1000-1000 (HLA)

Product Code	Clear Opening	Tray Depth	Reduced Opening	Visible Frame Size
KFRAC1000/1000(HLA)	1000mm x 1000mm	80mm	1000mm x 800mm	1375mm x 1375mm

This is the smallest Emergency Access Hatch in this family of products.

For the maximum size please see the KFRAC4000-1000(HLA)



Intumescent Seal

Graphite based intumescent seal, which creates high pressure on expansion. In order to guarantee a secure seal against the spread of smoke and fire, the seal engages at 150°C, ensuring the joints to close quickly to block the spread of smoke and fire.



Fire Cladding

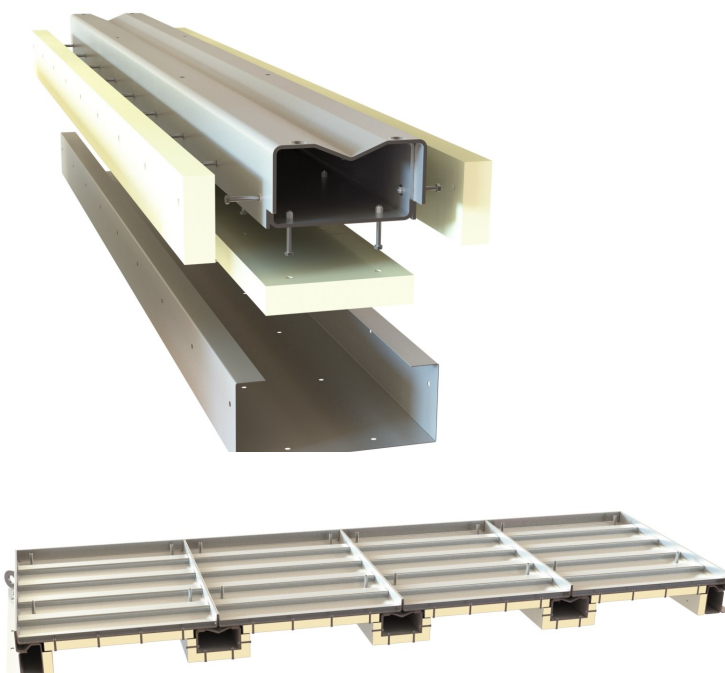

With its layers of fireboard cladding on the underside of our covers, these manhole covers provides thermal insulation, noise prevention and are non combustible according to DIN 4102 and WN 13501, with a shrinkage threshold of 400°C.



KENT HINGED SINGLE FIRE RATED ACCESS COVER KFRAC1000-1000 (HLA)

Kent
STAINLESS

3rd Party Certified

British Standard



Exova Test Report



**150°C
Intumescent
Seal
400°C Fire
Cladding**



Certifire



State of Qatar

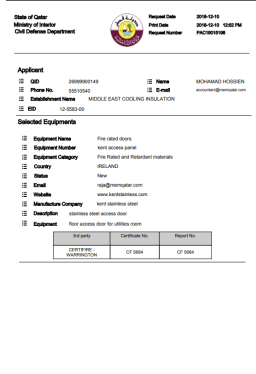

With it's layers of Intumescent Seal these covers have been proven to pass an Integrity Test of 180 minutes when tested with a Flaming Test, a Gap Gauge Test and a Cotton Pad Ignition Test.

In addition, with it's layers of fireboard cladding the underside of our covers, these manhole covers have passed the Insulation Test of 180 minutes.

These tests give it a 180 minute rating.

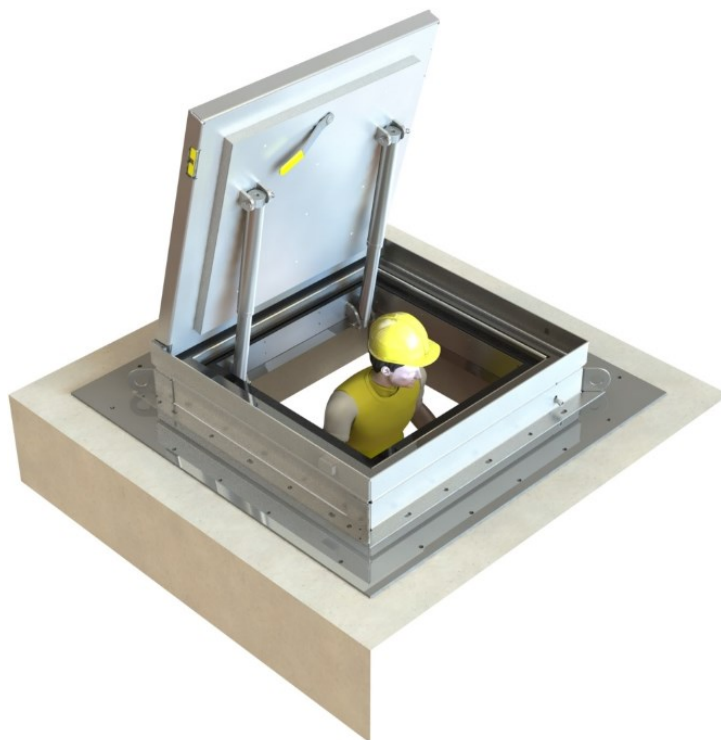



Mechanical Struts

Option 1: Standard Mechanical Strut

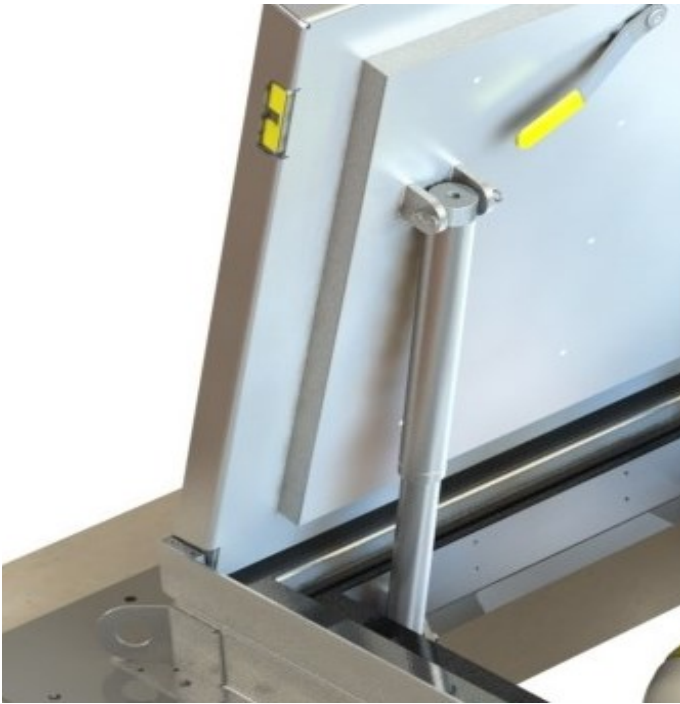

Option 2: Hand Hydraulic Pump

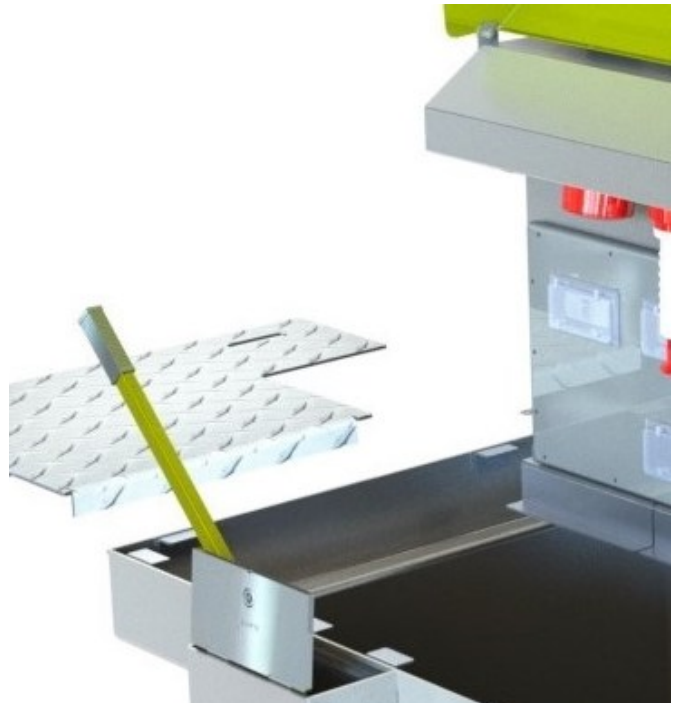

Option 3: Hydraulic

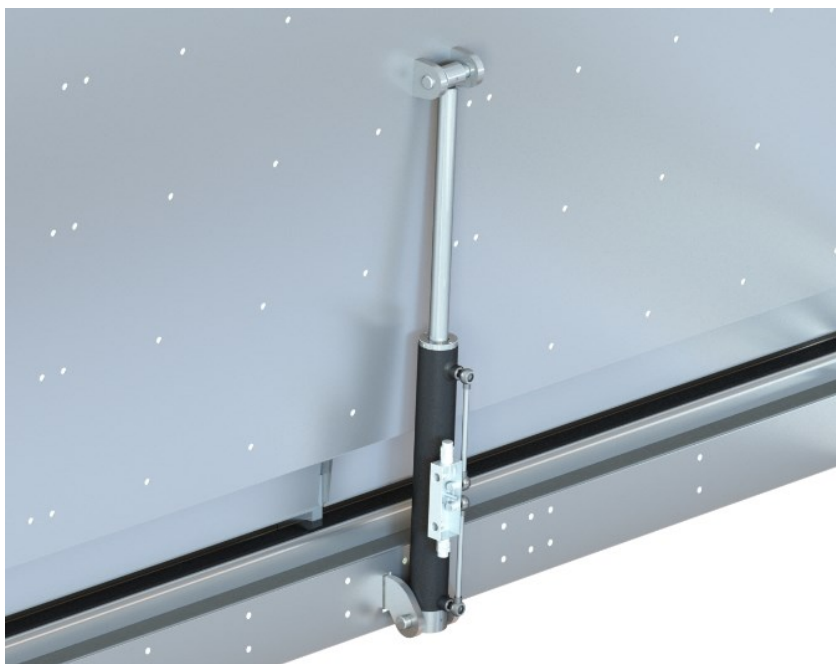



Water Management Channel System

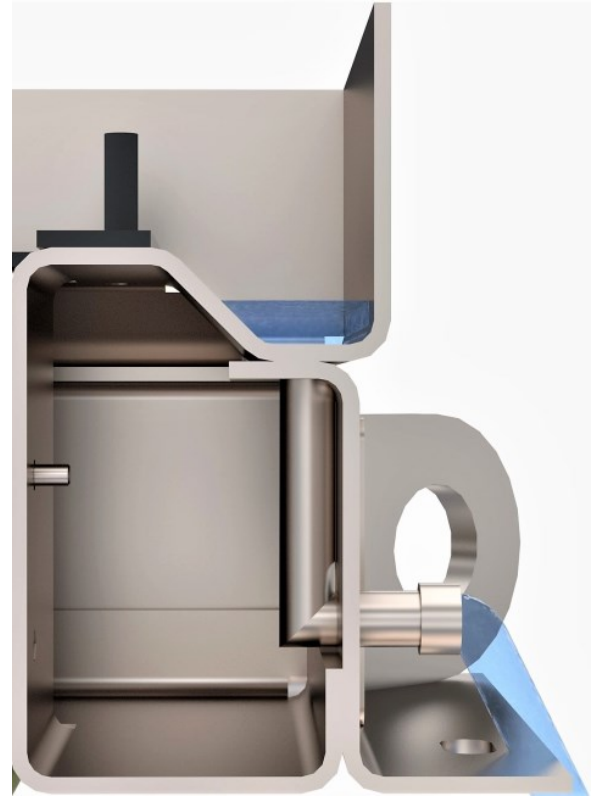
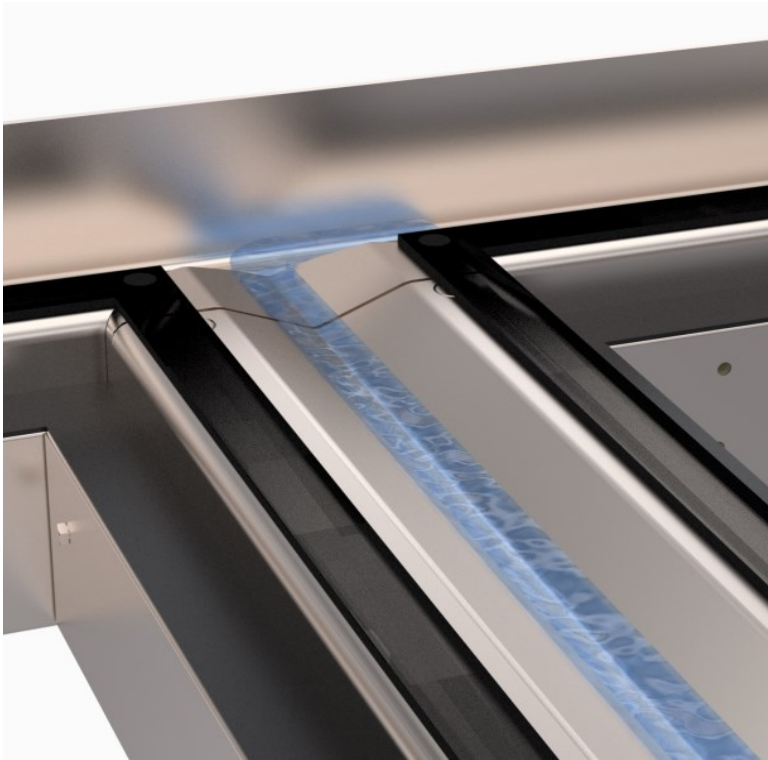

To properly engage to water management channel system the manhole frame has 25mm diameter outlet which must be connected to a positive drainage outlet pipe and not just a soakaway.

KENT HINGED SINGLE FIRE RATED ACCESS COVER KFRAC1000-1000 (HLA)

Specify

Choose your steel:
Grade 304 Stainless steel
Grade 316 Stainless steel

Customise your size, or go with our standard clear opening
4000mm x 1000mm

Specify:

Kent KFRAC1000/1000 Fire Rated Access Cover; 1000mm x 1000mm clear opening, 1375mm x 1375mm Visible Frame Size; Grade 316L Stainless Steel; Lockdown; Covers Recessed 80mm to take Concrete & Tiles (Alternatively 60mm Deep Pavers with Bedding); Integrated Water Management Channel with ½" BSP Drainage Point which must be connected to drainage system; 3rd Party Certified to give 180 Minute Fire Rating for Integrity and Insulation (Thermal Transfer); Loading 5kN/m² Eurocodes 2; Structural Design to Eurocodes 3





Kent Stainless Ltd

Arcavan, Wexford, Ireland

TEL NO: +353 53 9143216
UK FREEPHONE: 0800 376 8377
FAX: +353 53 9141802
WEB: www.kentstainless.com
EMAIL: info@kentstainless.com

